

P-Channel MOSFET

AO4459DY (KO4459DY)

■ Features

- $V_{DS} = -30V$
- $I_D = -6.5 A$ ($V_{GS} = -10V$)
- $R_{DS(ON)} < 46m\Omega$ ($V_{GS} = -10V$)
- $R_{DS(ON)} < 72m\Omega$ ($V_{GS} = -4.5V$)

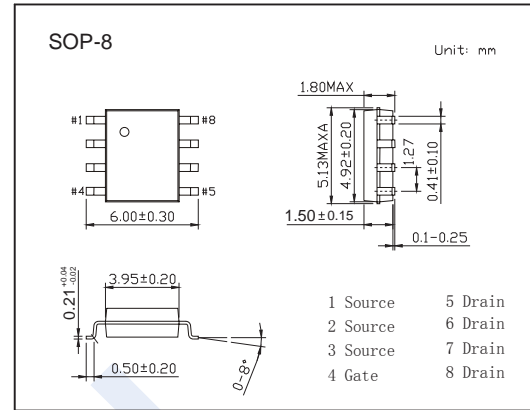
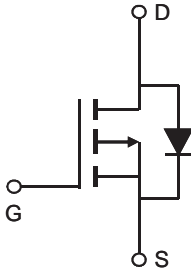

■ Absolute Maximum Ratings $T_a = 25^\circ C$

Parameter	Symbol	Rating	Unit
Drain-Source Voltage	V_{DS}	-30	V
Gate-Source Voltage	V_{GS}	± 20	
Continuous Drain Current	I_D	$T_A = 25^\circ C$	A
		$T_A = 70^\circ C$	
Pulsed Drain Current	I_{DM}	-30	
Avalanche Current	I_{AS}, I_{AR}	17	
Avalanche Energy	$L = 0.1mH$	E_{AS}, E_{AR}	mJ
Power Dissipation	P_D	$T_A = 25^\circ C$	W
		$T_A = 70^\circ C$	
Thermal Resistance.Junction- to-Ambient	R_{thJA}	$t \leq 10s$	$^\circ C/W$
		Steady-State	
Thermal Resistance.Junction- to-Lead	R_{thJL}	24	
Junction Temperature	T_J	150	$^\circ C$
Junction Storage Temperature Range	T_{stg}	-55 to 150	

P-Channel MOSFET

AO4459DY (KO4459DY)

■ Electrical Characteristics Ta = 25°C

Parameter	Symbol	Test Conditions	Min	Typ	Max	Unit
Drain-Source Breakdown Voltage	V _{DSS}	I _D =-250 μA, V _{GS} =0V	-30			V
Zero Gate Voltage Drain Current	I _{DSS}	V _{DS} =-30V, V _{GS} =0V			-1	μA
		V _{DS} =-30V, V _{GS} =0V, T _J =55°C			-5	
Gate-Body leakage current	I _{GSS}	V _{DS} =0V, V _{GS} =±20V			±100	nA
Gate Threshold Voltage	V _{GS(th)}	V _{DS} =V _{GS} , I _D =-250μA	-1.4		-2.4	V
Static Drain-Source On-Resistance	R _{DS(on)}	V _{GS} =-10V, I _D =-6.5A			46	mΩ
		V _{GS} =-10V, I _D =-6.5A T _J =125°C			68	
		V _{GS} =-4.5V, I _D =-5A			72	
On state drain current	I _{D(ON)}	V _{GS} =-10V, V _{DS} =-5V	-30			A
Forward Transconductance	g _{FS}	V _{DS} =-5V, I _D =-6.5A		14		S
Input Capacitance	C _{iss}	V _{GS} =0V, V _{DS} =-15V, f=1MHz		520		pF
Output Capacitance	C _{oss}			100		
Reverse Transfer Capacitance	C _{rss}			62		
Gate resistance	R _g	V _{GS} =0V, V _{DS} =0V, f=1MHz	3.5		11.5	Ω
Total Gate Charge (10V)	Q _g	V _{GS} =-10V, V _{DS} =-15V, I _D =-6.5A		9.2	11	nC
Total Gate Charge (4.5V)				4.6	6	
Gate Source Charge	Q _{gs}			1.6		
Gate Drain Charge	Q _{gd}			2.2		
Turn-On DelayTime	t _{d(on)}			7.5		
Turn-On Rise Time	t _r	V _{GS} =-10V, V _{DS} =-15V, R _L =2.5Ω, R _{GEN} =3Ω		5.5		ns
Turn-Off DelayTime	t _{d(off)}			19		
Turn-Off Fall Time	t _f			7		
Body Diode Reverse Recovery Time	t _{rr}			11		
Body Diode Reverse Recovery Charge	Q _{rr}	I _F =-6.5A, di/dt=100A/us		5.3		nC
Maximum Body-Diode Continuous Current	I _S				-3.5	A
Diode Forward Voltage	V _{SD}	I _S =-1A, V _{GS} =0V			-1	V

Note :The static characteristics in Figures 1 to 6 are obtained using <300us pulses, duty cycle 0.5% max.

■ Marking

Marking	4459
	KC****

P-Channel MOSFET AO4459DY (KO4459DY)

■ Typical Characteristics

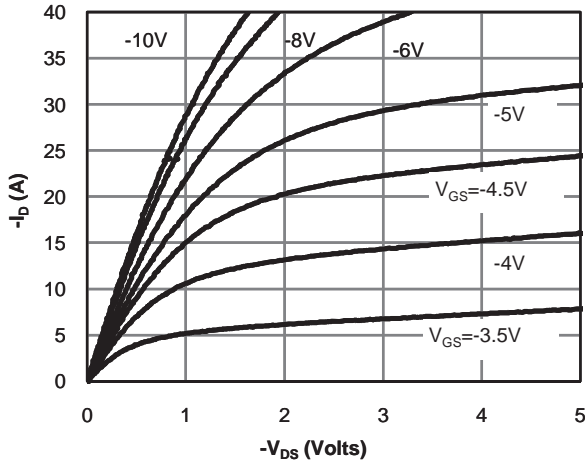

Fig 1: On-Region Characteristics (Note E)

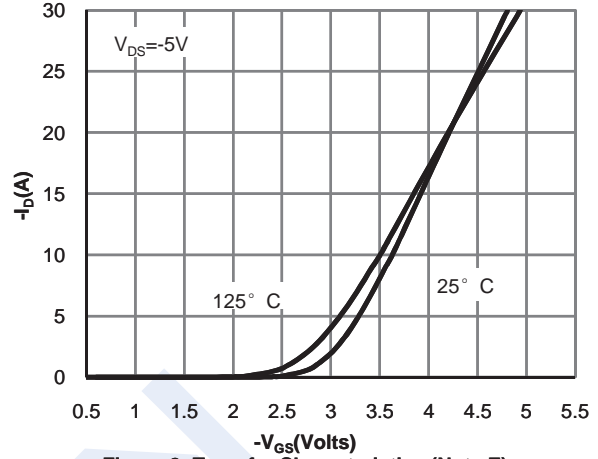

Figure 2: Transfer Characteristics (Note E)

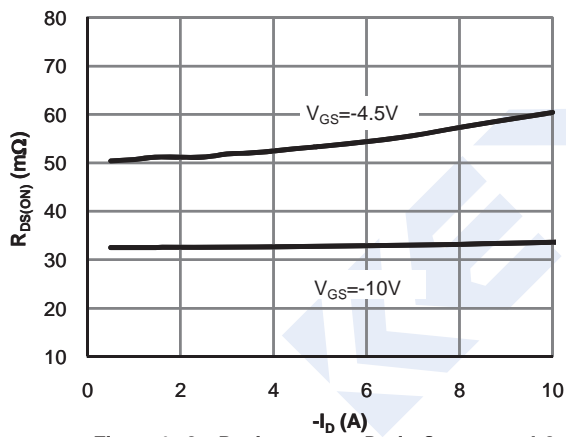

Figure 3: On-Resistance vs. Drain Current and Gate Voltage (Note E)

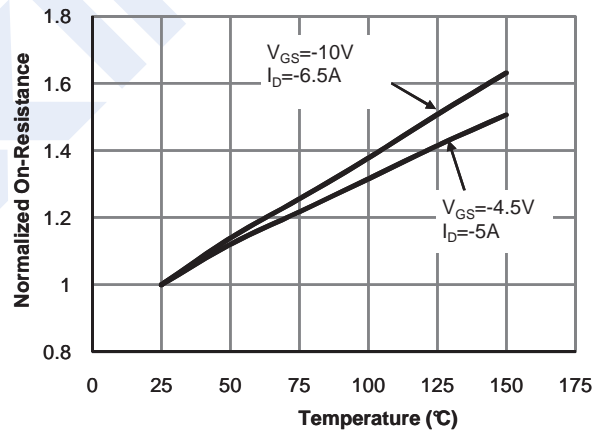

Figure 4: On-Resistance vs. Junction Temperature

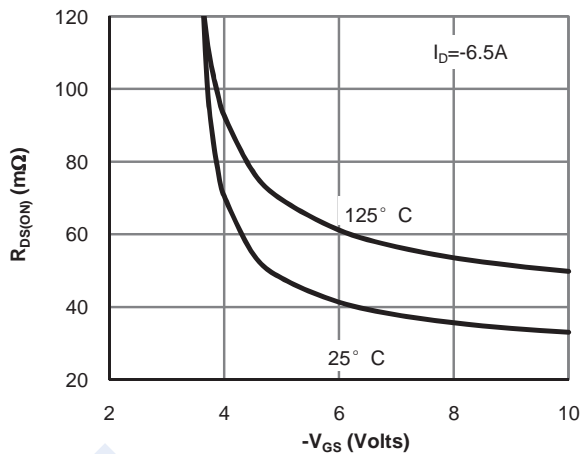

Figure 5: On-Resistance vs. Gate-Source Voltage (Note E)

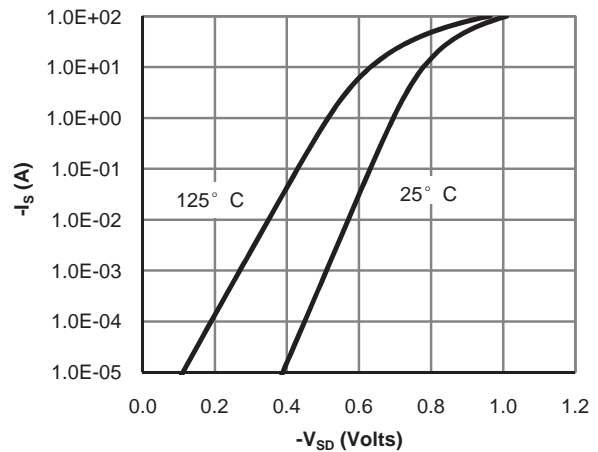

Figure 6: Body-Diode Characteristics (Note E)

P-Channel MOSFET AO4459DY (KO4459DY)

■ Typical Characteristics

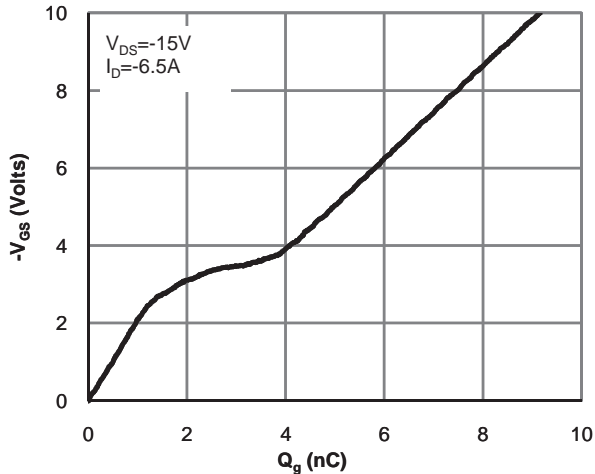

Figure 7: Gate-Charge Characteristics

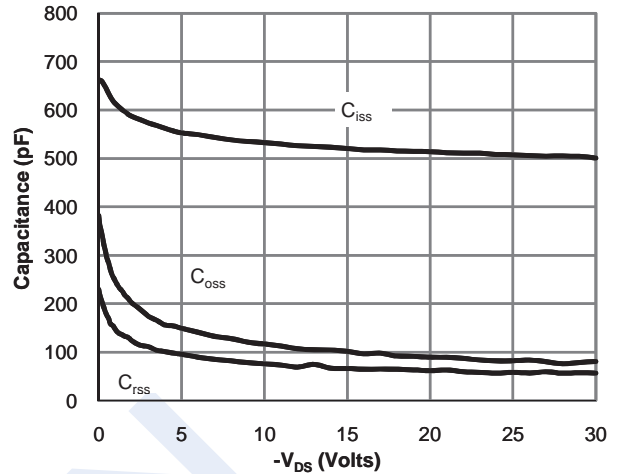

Figure 8: Capacitance Characteristics

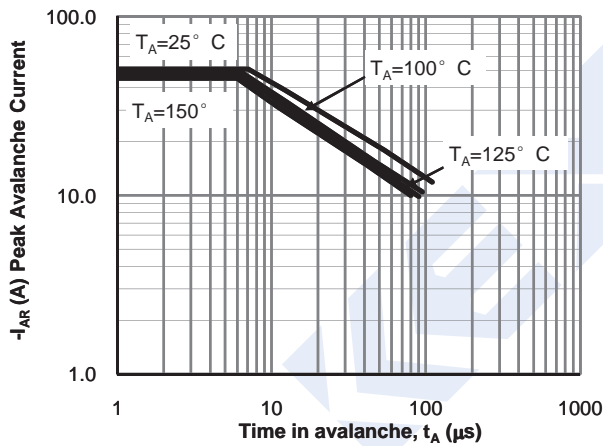

Figure 9: Single Pulse Avalanche capability (Note C)

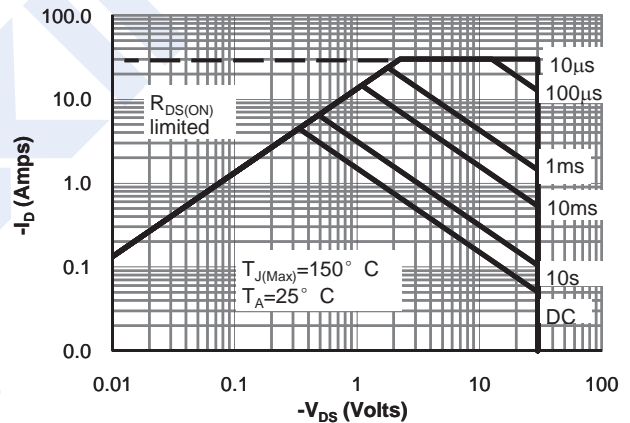

Figure 10: Maximum Forward Biased Safe Operating Area (Note F)

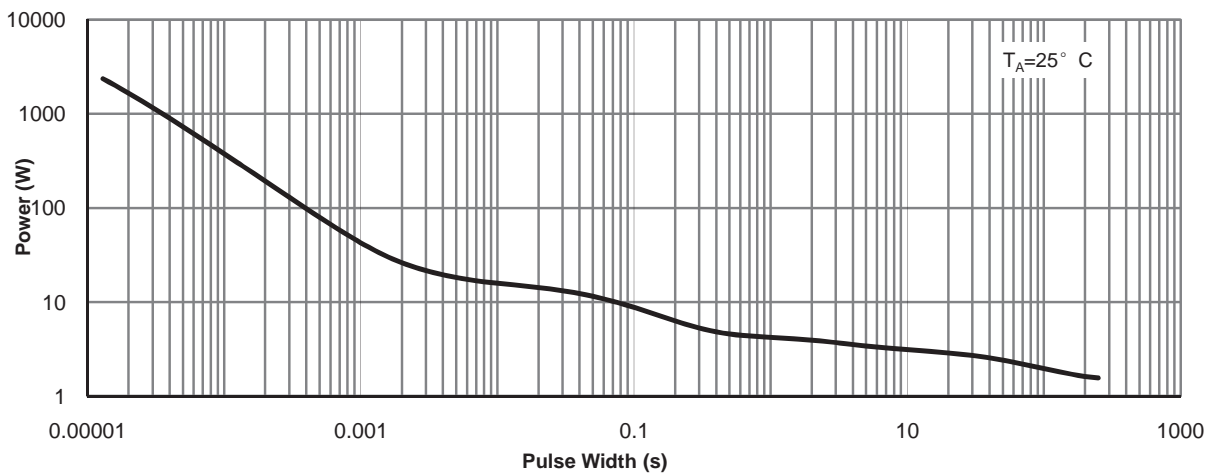

Figure 11: Single Pulse Power Rating Junction-to-Ambient (Note F)

P-Channel MOSFET AO4459DY (KO4459DY)

■ Typical Characteristics

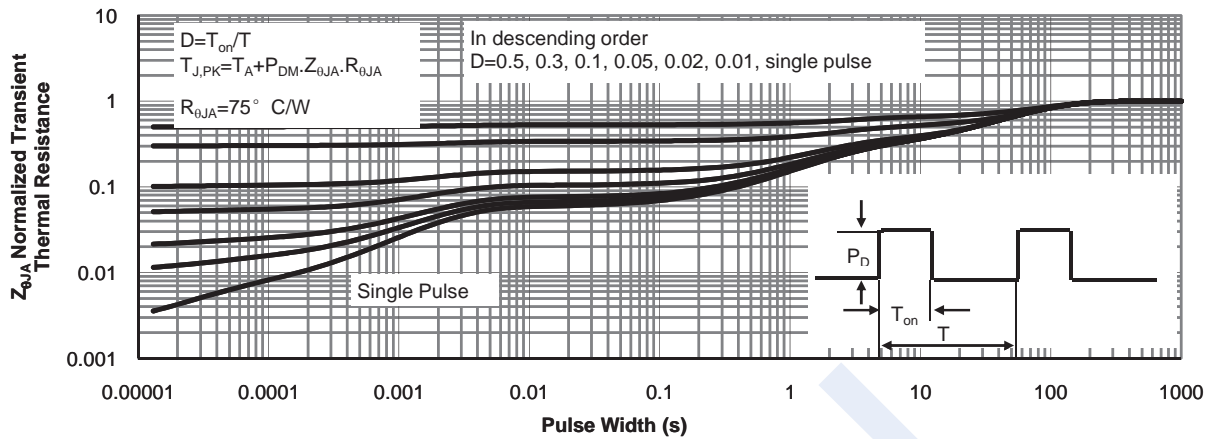

Figure 12: Normalized Maximum Transient Thermal Impedance (Note F)