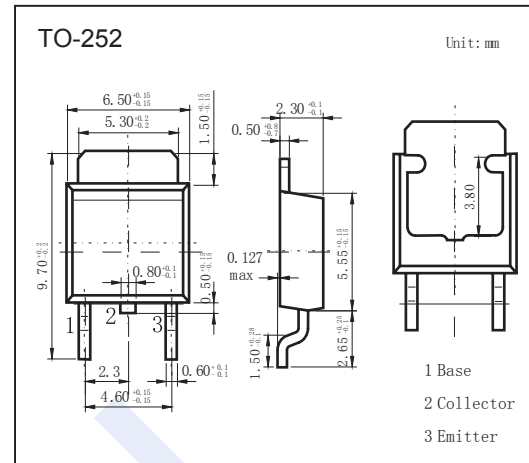

NPN Transistors

2SD1758

■ Features

- Low $V_{CE(sat)}$
- Complementary to 2SB1182

■ Absolute Maximum Ratings $T_a = 25^\circ\text{C}$

Parameter	Symbol	Rating	Unit
Collector - Base Voltage	V_{CBO}	40	V
Collector - Emitter Voltage	V_{CEO}	32	
Emitter - Base Voltage	V_{EBO}	5	
Collector Current - Continuous	I_C	2	A
Collector Current - Pulse	I_{CP}	2.5	
Collector Power Dissipation $T_c=25^\circ\text{C}$	P_C	10	W
Junction Temperature	T_J	150	$^\circ\text{C}$
Storage Temperature Range	T_{stg}	-55 to 150	

■ Electrical Characteristics $T_a = 25^\circ\text{C}$

Parameter	Symbol	Test Conditions	Min	Typ	Max	Unit
Collector- base breakdown voltage	V_{CBO}	$I_C = 100 \mu\text{A}$, $I_E = 0$	40			V
Collector- emitter breakdown voltage	V_{CEO}	$I_C = 1 \text{ mA}$, $I_B = 0$	32			
Emitter - base breakdown voltage	V_{EBO}	$I_E = 100 \mu\text{A}$, $I_C = 0$	5			
Collector-base cut-off current	I_{CBO}	$V_{CB} = 30 \text{ V}$, $I_E = 0$			1	μA
Emitter cut-off current	I_{EBO}	$V_{EB} = 4 \text{ V}$, $I_C = 0$			0.5	
Collector-emitter saturation voltage	$V_{CE(sat)}$	$I_C = 2 \text{ A}$, $I_B = 200 \text{ mA}$		0.5	0.8	V
Base - emitter saturation voltage	$V_{BE(sat)}$	$I_C = 2 \text{ A}$, $I_B = 200 \text{ mA}$			1.2	
DC current gain	h_{FE}	$V_{CE} = 3 \text{ V}$, $I_C = 500 \text{ mA}$	120		390	
Collector Output capacitance	C_{ob}	$V_{CB} = 10 \text{ V}$, $I_E = 0$, $f = 1 \text{ MHz}$		30		pF
Transition frequency	f_T	$V_{CE} = 5 \text{ V}$, $I_E = -50 \text{ mA}$, $f = 100 \text{ MHz}$		100		MHz

■ Classification of h_{fe}

Type	2SD1758-Q	2SD1758-R
Range	120-270	180-390

NPN Transistors

2SD1758

Typical Characteristics

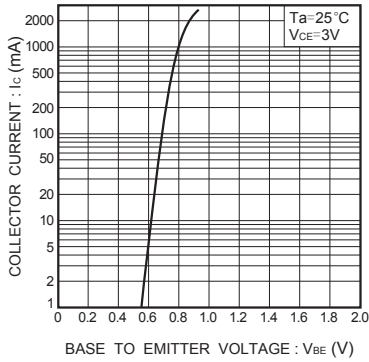

Fig.1 Grounded emitter propagation characteristics

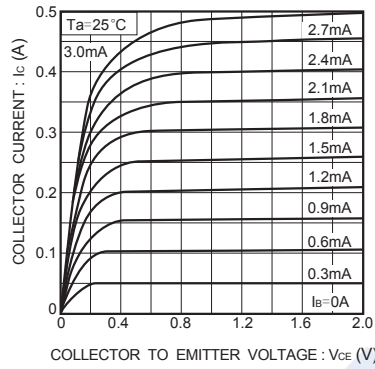

Fig.2 Grounded emitter output characteristics

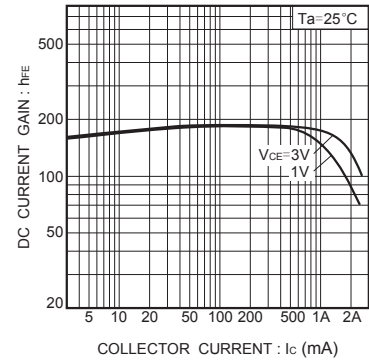

Fig.3 DC current gain vs. collector current

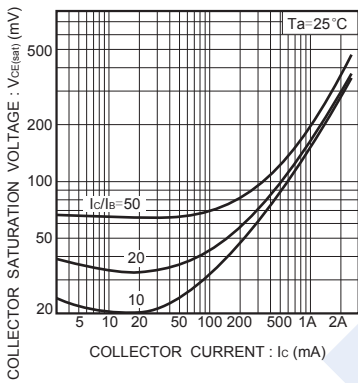

Fig.4 Collector-emitter saturation voltage vs. collector current

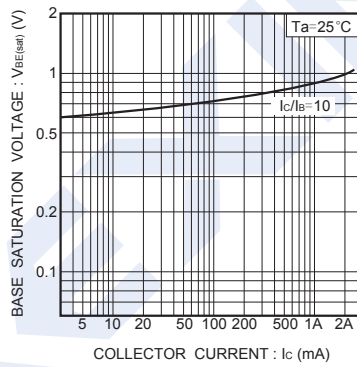

Fig.5 Collector-emitter saturation voltage vs. collector current

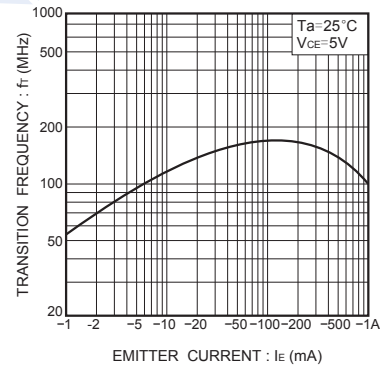

Fig.6 Transition frequency vs. emitter current

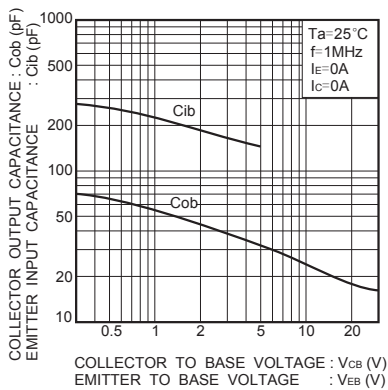

Fig.7 Collector output capacitance vs. collector-base voltage
Emitter input capacitance vs. emitter-base voltage

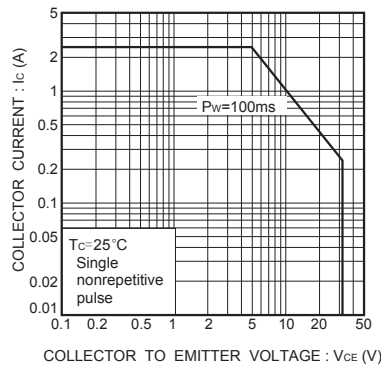

Fig.8 Safe operating area