

PNP Transistors

2SB1571

■ Features

- Low collector-emitter saturation voltage
- Complementary to 2SD2402

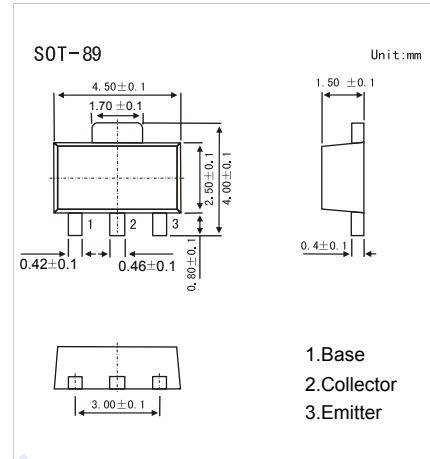

■ Absolute Maximum Ratings $T_a = 25^\circ\text{C}$

Parameter	Symbol	Rating	Unit
Collector - Base Voltage	V_{CB0}	-50	V
Collector - Emitter Voltage	V_{CE0}	-30	
Emitter - Base Voltage	V_{EB0}	-6	
Collector Current - Continuous	I_C	-5	A
Collector Current - Pulse	I_{CP}	-8	
Collector Power Dissipation	P_C	2	W
Junction Temperature	T_J	150	$^\circ\text{C}$
Storage Temperature range	T_{stg}	-55 to 150	

■ Electrical Characteristics $T_a = 25^\circ\text{C}$

Parameter	Symbol	Test Conditions	Min	Typ	Max	Unit	
Collector- base breakdown voltage	V_{CB0}	$I_C = -100 \mu\text{A}$, $I_E = 0$	-50			V	
Collector- emitter breakdown voltage	V_{CE0}	$I_C = -1 \text{ mA}$, $I_B = 0$	-30				
Emitter - base breakdown voltage	V_{EB0}	$I_E = -100 \mu\text{A}$, $I_C = 0$	-6				
Collector-base cut-off current	I_{CB0}	$V_{CB} = -50\text{V}$, $I_E = 0$			-0.1	μA	
Emitter cut-off current	I_{EB0}	$V_{EB} = -6\text{V}$, $I_C = 0$			-0.1		
Collector-emitter saturation voltage	$V_{CE(sat)}$	$I_C = -3 \text{ A}$, $I_B = -150 \text{ mA}$		-0.17	-0.35	V	
		$I_C = -5 \text{ A}$, $I_B = -250 \text{ mA}$		-0.28	-0.55		
Base - emitter saturation voltage	$V_{BE(sat)}$	$I_C = -3 \text{ A}$, $I_B = -150 \text{ mA}$		-0.89	-1.2	V	
Base - emitter voltage	V_{BE}	$V_{CE} = -1\text{V}$, $I_C = -100 \text{ mA}$	-0.6		-0.7		
DC current gain	h_{FE}	$V_{CE} = -1\text{V}$, $I_C = -1 \text{ A}$	80				
		$V_{CE} = -1\text{V}$, $I_C = -2 \text{ A}$	100	200	400		
Turn-on Time	t_{on}	$I_C = -2.0 \text{ A}$, $V_{CC} = -10 \text{ V}$, $R_L = 5.0 \Omega$, $I_{B1} = -I_{B2} = -0.1 \text{ A}$,		265		ns	
Storage Time	t_{stg}				350		
Fall Time	t_f				50		
Collector output capacitance	C_{ob}	$V_{CB} = -10\text{V}$, $I_E = 0$, $f = 1\text{MHz}$		100		pF	
Transition frequency	f_r	$V_{CE} = -10\text{V}$, $I_E = 500 \text{ mA}$		150		MHz	

■ Classification of $h_{fe}(2)$

Type	2SB1571-X	2SB1571-Y	2SB1571-Z
Range	100-200	160-320	200-400
Marking	HX	HY	HZ

PNP Transistors

2SB1571

Typical Characteristics

DERATING FACTOR OF FORWARD BIAS SAFE OPERATING AREA

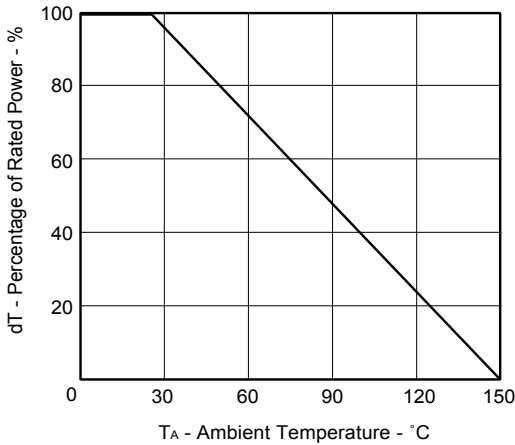

FORWARD BIAS SAFE OPERATING AREA

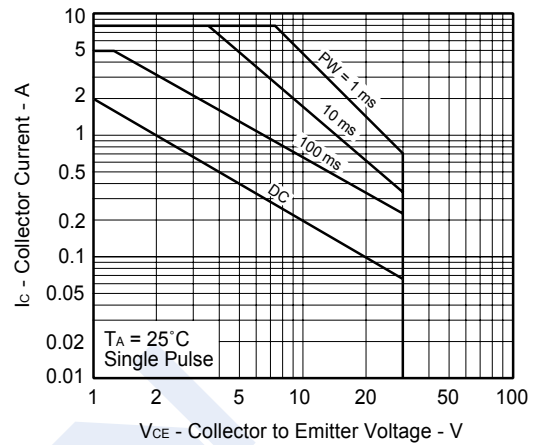

COLLECTOR CURRENT vs. COLLECTOR TO EMITTER VOLTAGE

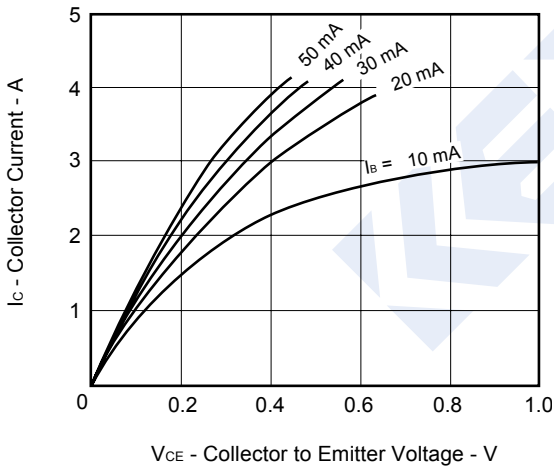

COLLECTOR CURRENT vs. BASE TO EMITTER VOLTAGE

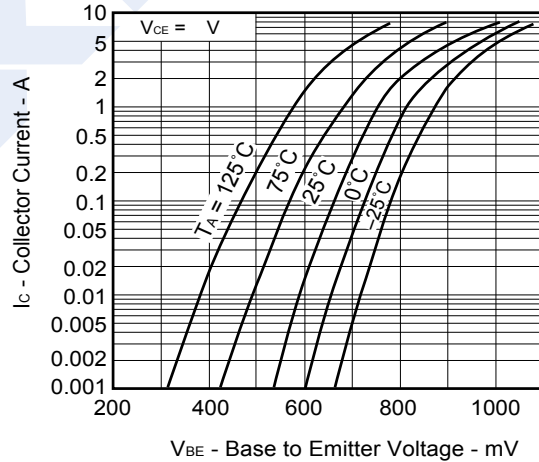

DC CURRENT GAIN vs. COLLECTOR CURRENT

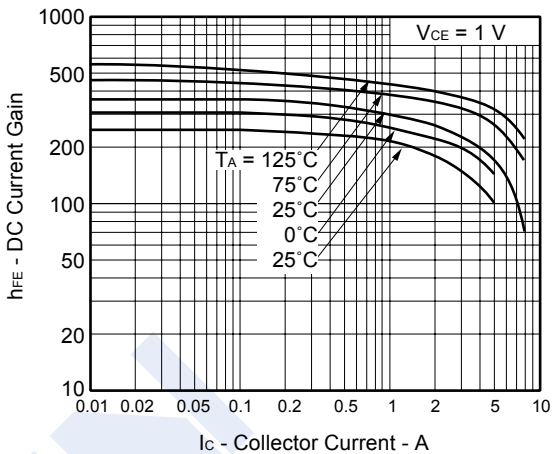

COLLECTOR SATURATION VOLTAGE vs. COLLECTOR CURRENT

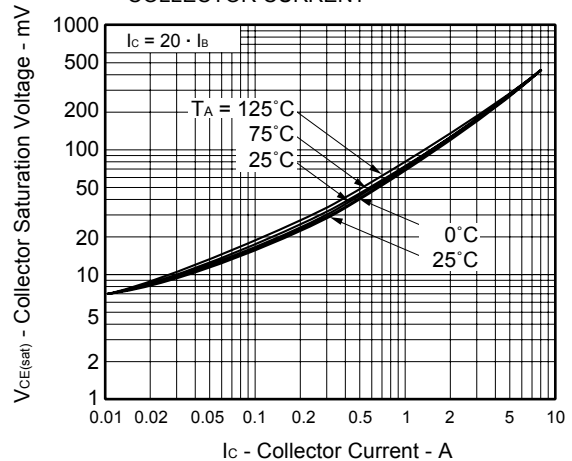

PNP Transistors

2SB1571

■ Typical Characteristics

COLLECTOR SATURATION VOLTAGE vs. COLLECTOR CURRENT

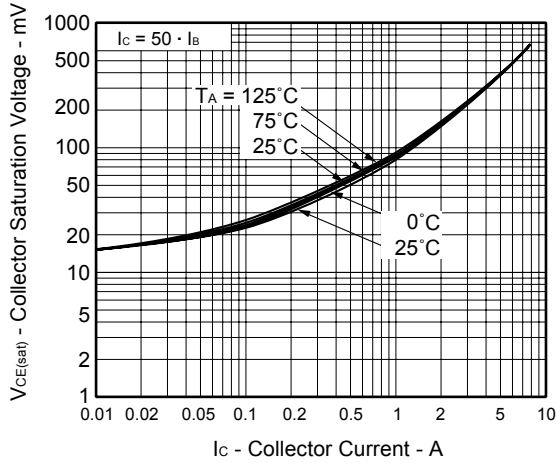

BASE SATURATION VOLTAGE vs. COLLECTOR CURRENT

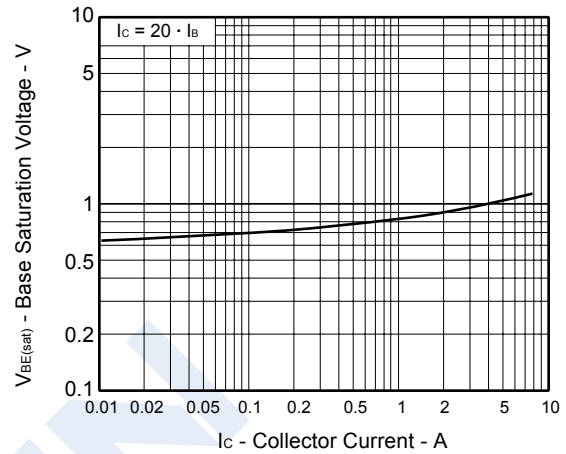

GAIN BANDWIDTH PRODUCT vs. EMITTER CURRENT

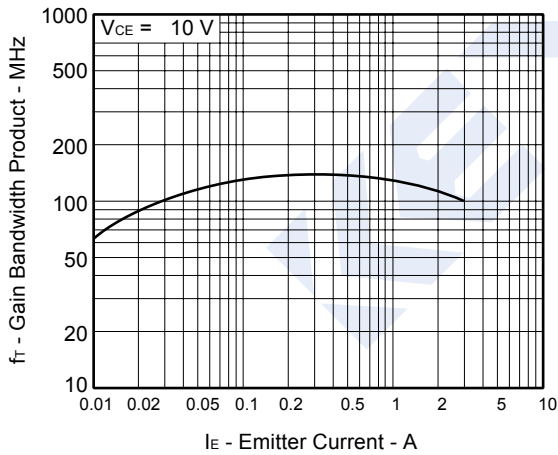

OUTPUT CAPACITANCE vs. REVERSE VOLTAGE

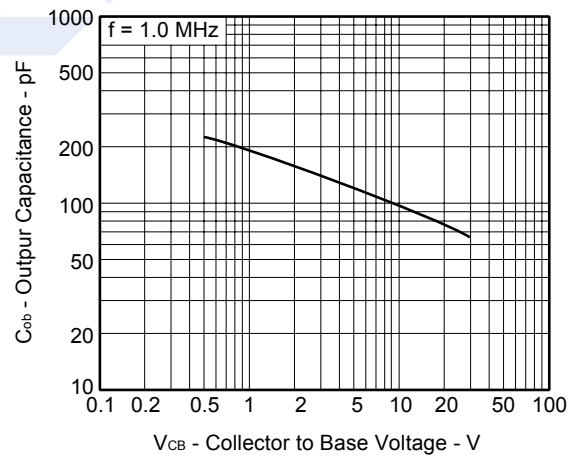

SWITCHING CHARACTERISTICS

